

BEIJING HUADE HYDRAULIC INDUSTRIAL GROUP CO.,LTD.	Directional control valves, manual operation, Type WMD			RE 23500/12.2004
	Size 6 to 10	up to 31.5 MPa	up to 120L/min	Replaces: RE 22279/05.2001

Features:

- Direct controlled directional spool valve
- subplate mounting
- Porting pattern to Din 24 340 form A, ISO 4401 and CETOP-RP 121H

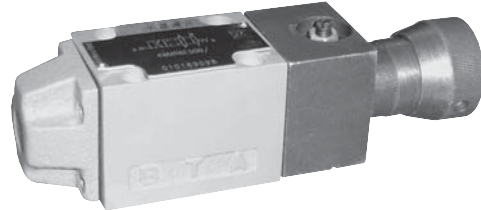

Functional , section

Directional valves type WMD are manual operated directional spool valves. They control the start, stop and direction of a volume flow.

The valves consist basically of the housing (1), an operating rotary knob(2), the control spool (3), and one return springs (4). In an unoperated condition, the control spool (3) is held in the neutral or starting position by the return springs (4) - or by a detent .The control spool (3) is pushed into the required control position by means of the operating element.

Detent

Directional valves with rotary knob operation are supplied with detent as standard. it is possible to fix any control position.

Cartridge throttle

Use of the cartridge throttle is necessary when operating conditions are such, that during the switching process larger flows can occur than the performance limits of the valve allow. It is fitted in the P-line of the directional valve or in the control circuit.

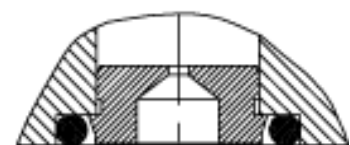
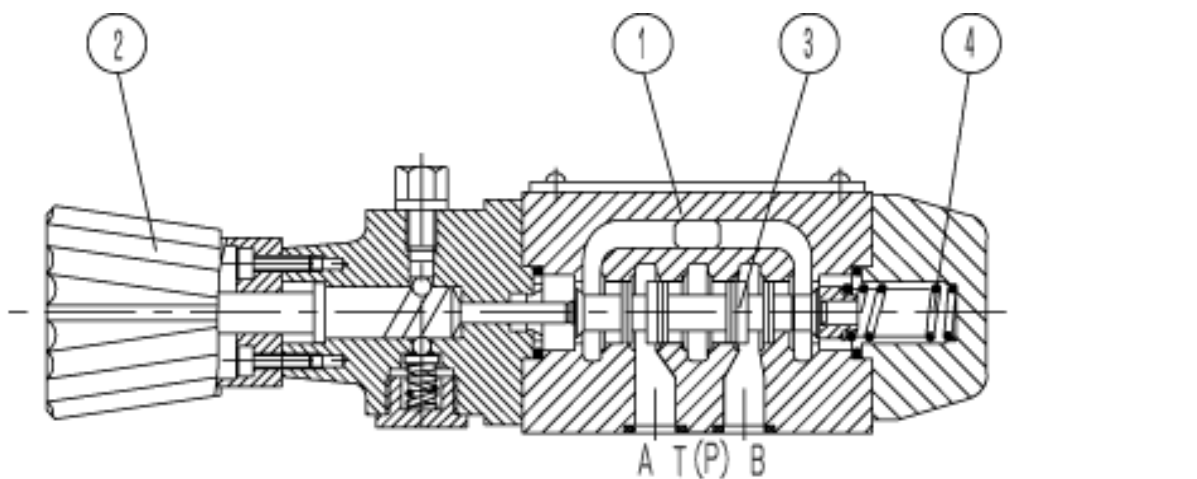

Cartridge throttle

Ordering detail

	WMD				B	/	*
3 service ports =3							Further details in clear text
4 service ports =4							No code = Mineral oils V = Phosphate ester
Size 6 =6							B = The technology of Beijing Huade Hydraulic
Size 10 =10							
							50 = Series 50 to 59 (50 to 59 = unchanged installation and connection dimensions) (size 6)
							30 = Series 30 to 39 (30 to 39 = unchanged installation and connection dimensions) (size 10)

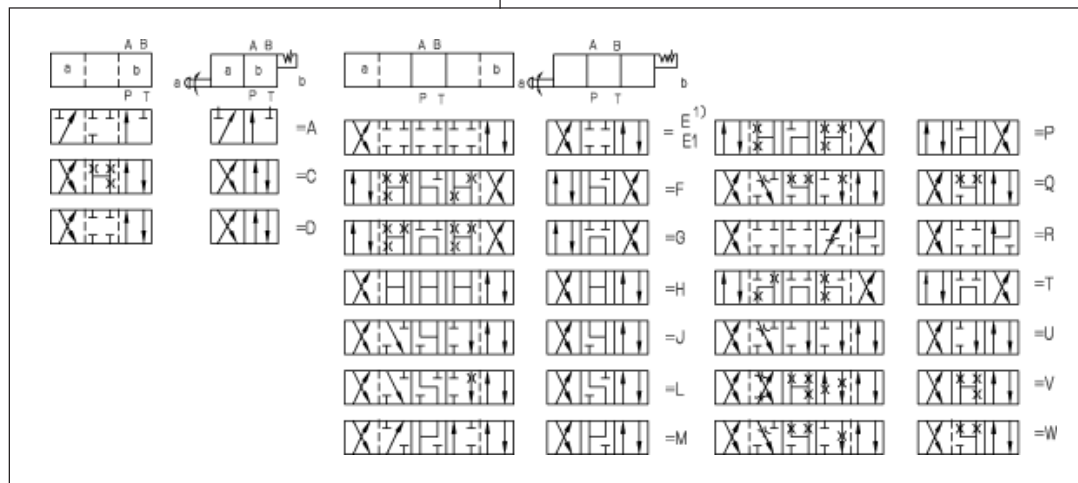

Symbol E1: P A/B pre-opening (only for size 6)

Example:

Spool type E with switched position "a", Ordering code ..EA..

Spool type E with switched position "b", Ordering code ..EB..

Technical data (For applications outside these parameters, please consult us!)

Size	6	10
Operating pressure	up to 31.5	
ports A, B, P (MPa)		
ports T (MPa)	Up to 6	Up to 16
for symbols A or B, port T must be used as a drain port if the operating pressure is higher than the permissible tank pressure.		
Flow.max (L/min)	Up to 60	Up to 120
Flow cross section (control position O)	for symbol Q, 6% of nominal cross section for symbol W 3% of nominal cross section	
Pressure fluid	Mineral oils(for NBR seal) or phosphate ester(for FPM seal)	
Pressure fluid - temperature range (°C)	-20 to +80	
Viscosity range (mm ² /s)	2.8 to 500	
Weights (Kg)	Approx.1.4	Approx.3.3
Operating force (N)	Approx.150	Approx.250

Characteristic curves (measured at $V = 41 \text{ mm}^2/\text{s}$ and $t = 50^\circ\text{C}$)

Pressure difference flow curves, type WMD6

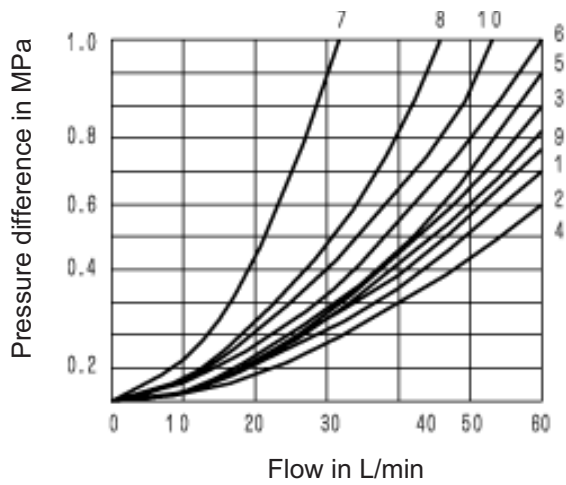

- 7.Symbol "R" in switched positions A-B
- 8.Symbol "G" and "T" in neutral position P-T

Symbol	Flow direction			
	P → A	P → B	A → T	B → T
A	3	3	-	-
C	1	1	3	1
D	5	5	3	3
E	3	3	1	1
F	1	3	1	1
G	6	6	9	9
H	2	4	2	2
J	1	1	2	1
L	3	3	4	9
M	2	4	3	3
P	3	1	1	1
Q	1	1	2	1
R	5	5	4	-
T	10	10	9	9
U	3	3	9	4
V	1	2	1	1
W	1	1	2	2

Pressure difference flow curves , type WMD10

- 4.Symbol "G" and "T" in neutral position P-T
- 7.Symbol "R" in switched positions A-B

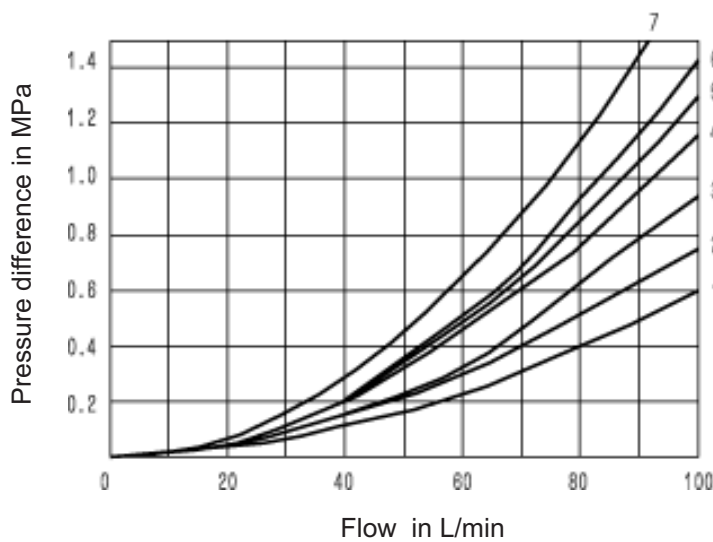

Symbol	Flow direction			
	P → A	P → B	A → T	B → T
A	2	2	-	-
C	2	2	3	3
D	2	2	3	3
E	2	2	4	4
F	2	3	3	5
G	3	3	4	6
H	1	1	4	5
J	2	2	3	3
L	2	2	3	5
M	1	1	5	5
P	3	2	5	3
Q	2	2	4	4
R	2	4	3	-
T	3	5	5	6
U	2	2	3	5
V	2	2	4	4
W	2	2	5	5

Performance limits (measured at $v = 41 \text{ mm}^2/\text{s}$ and $t = 50 \text{ }^\circ\text{C}$)

The performance limits shown apply when the valve is subject to simultaneous flow in two directions (e.g. from P to A and from B to T).

performance limits for one path(e.g. from P to A and with B blocked) may be considerably reduced!
(Please consult us in such cases.)

Due to the flow forces occurring within the valve, the permissible

Type WMD6

Curve	Symbol
1	E, E1, H, C, D, M, Q, U, W
2	J, L
3	A
4	G, P
5	F
6	V
7	R
8	T

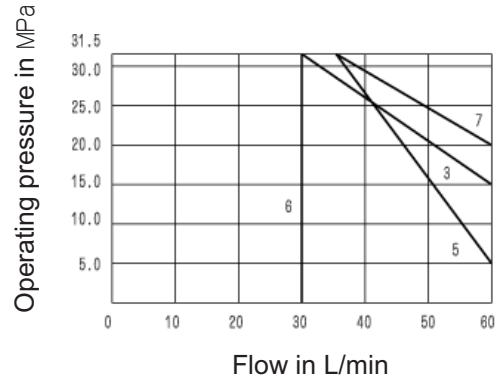
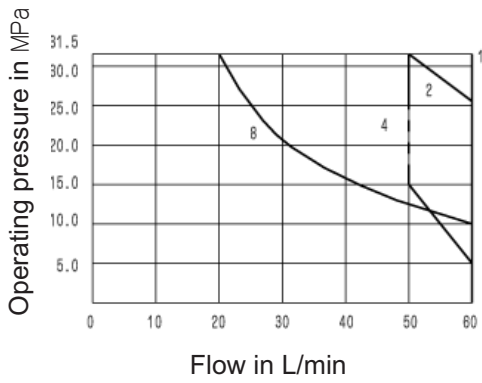

Type WMD10

Curve	Symbol
5	C, D, E, M, V, Y

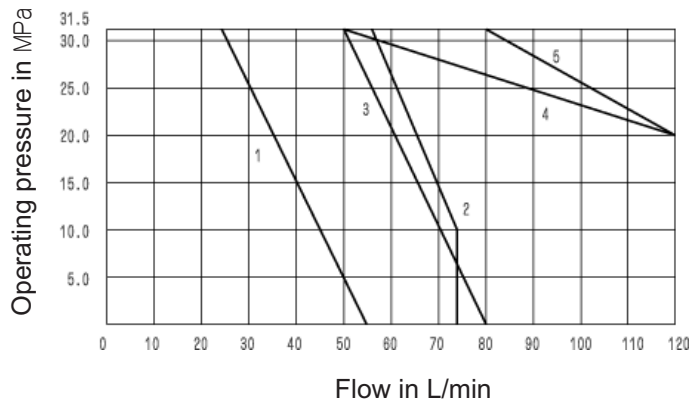

Unit dimensions

(Dimensions in mm)

Type WMD6

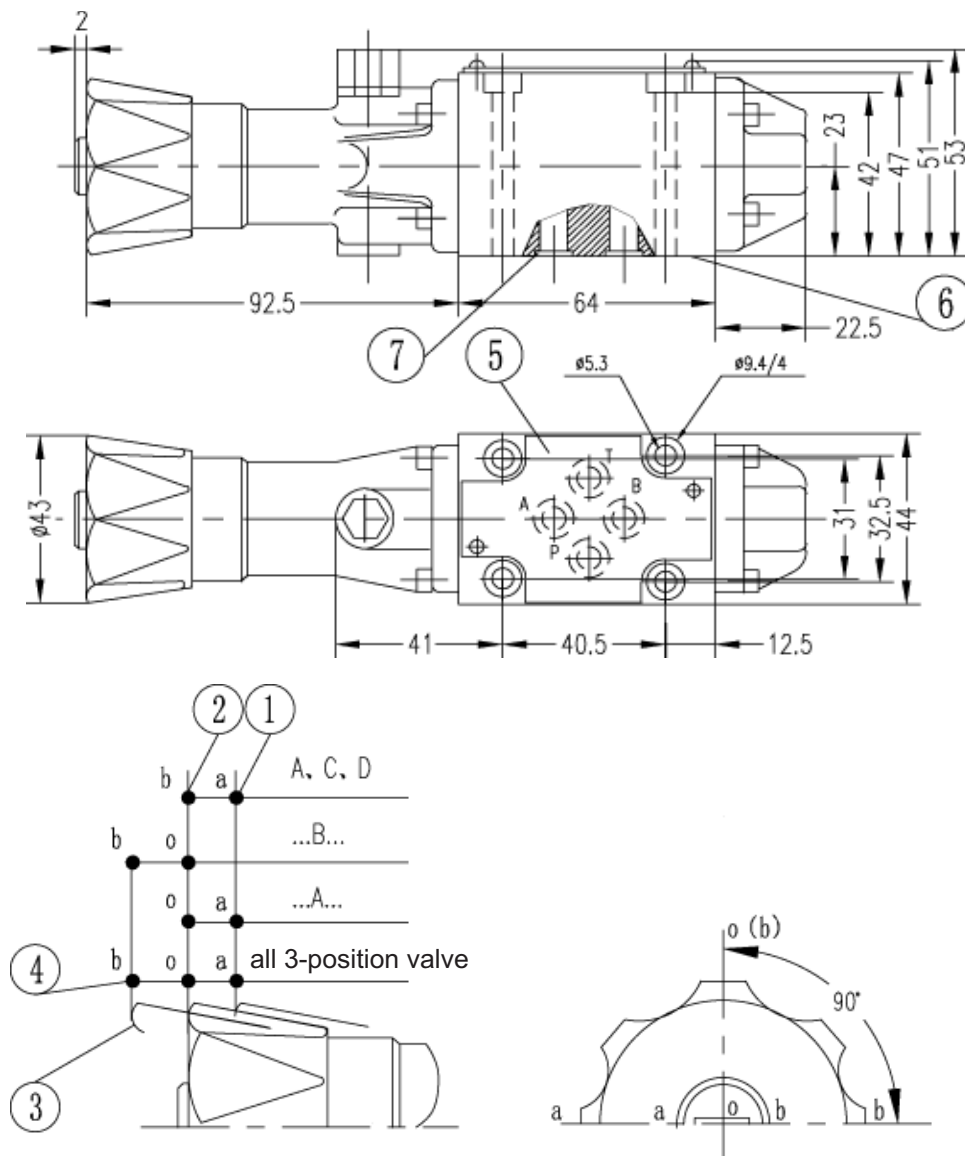

Unit dimensions for ports

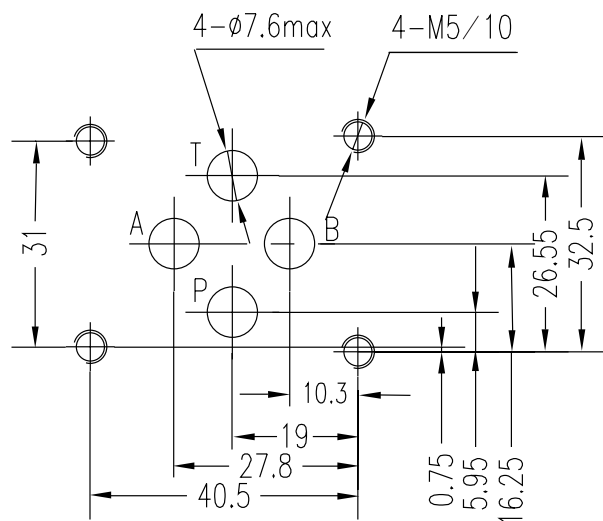

Subplates: see page 205

G341/01 (G1/4"); G341/02 (M14X1.5)

G342/01 (G3/8"); G342/02 (M18X1.5)

G502/01 (G1/2"); G502/02 (M22X1.5)

- 1. Switched position a
- 2. Switched position 0 and b
(b for 2-position valves)
- 3. Switched position b
- 4. Operating valve 90° clockwise and
90° anti-clockwise 3-position valve
- 5. Nameplate
- 6. Valve connecting surface
- 7. O-ring 9.25X1.78 (for ports A, B, P, and T)

Type WMD10

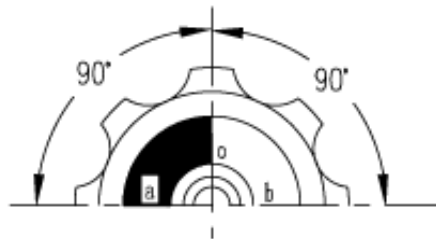
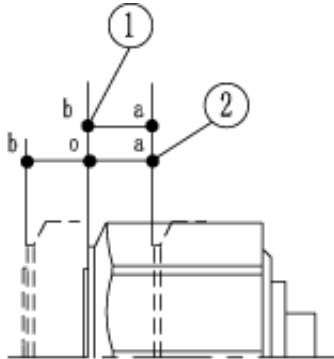
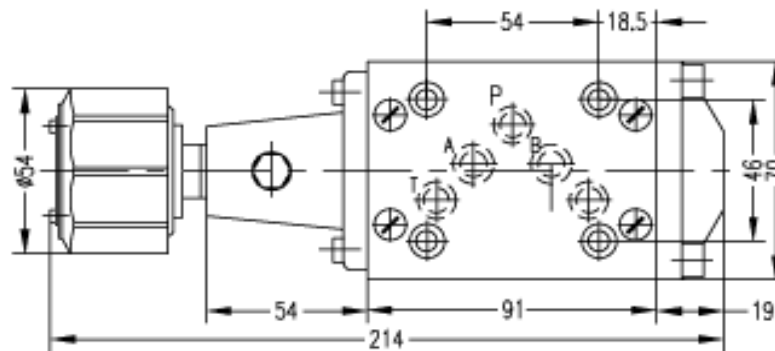
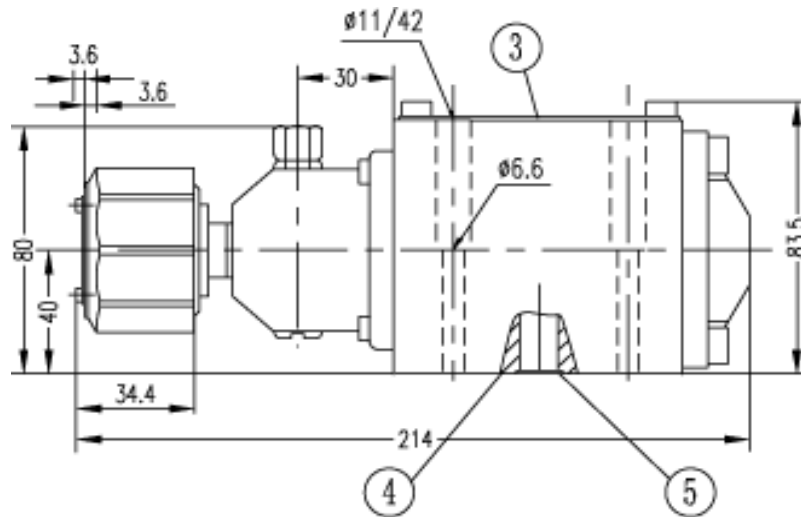

Unit dimensions for ports

Sub-plates: see page 206

G66/01 (G3/8"); G66/02 (M18X1.5)

G67/01 (G1/2"); G67/02 (M22X1.5)

G534/01 (G3/4"); G534/02 (M27X2)

- 1、 2-position valves: A、 C、 D、 ...EA...
- 2、 3-position
- 3、 Nameplate
- 5、 Connecting surface
- 6、 O-ring 9.25X1.78
(for ports A、 B、 P、 and T)

